

## ISTRUZIONI PER L'INSTALLATORE

IT

### Modulo per la programmazione della centrale 14A tramite smartphone

**Caratteristiche tecniche:**

Alimentazione	5 Vdc
Frequenza	2,4 GHz
Grado di protezione	IP 40
Consumo in trasmissione	20 mA
Antenna	incorporata
Temperatura di esercizio	-20 ÷ +55°C
Peso	12 g

### DESCRIZIONE DEL PRODOTTO E DESTINAZIONE D'USO

Modulo dedicato all'installatore per la programmazione wireless tramite smartphone della centrale 14A, da versione firmware 3.0. L'utilizzo di KUBE PRO è vincolato alla registrazione tramite App e all'abilitazione dell'account da parte di Key Automation. Compatibile con smartphone Android e Apple dotati di Bluetooth 4.0 LE e APP native per Android 5.0/iOS 9.3.5 o superiori con supporto multilingua.

riori con supporto multilingua.

### Ogni altro uso è improprio e vietato!

Il costruttore **Key Automation S.r.l.** Via Meucci 23, 30027 San Donà di Piave (VE) ITALIA Dichiaro che questo prodotto è conforme a tutte le norme tecniche relative al prodotto entro il campo di applicabilità della direttiva 2014/53/EU. Sono state eseguite tutte le necessarie prove di radiofrequenza.

EN 61000-6-2:2017  
EN 61000-6-3:2007 + A1:2011  
EN 301 489-1:2017 V2.2.0  
EN 301 489-17:2017 V3.2.0  
EN 300 328:2016 V2.1.1  
EN 62368-1:2014 + EC:2015 + A11:2017



Nicola Michelin  
(C.E.O.)

*Nicola Michelin*

## INSTRUCTIONS FOR THE INSTALLER

EN

### Smartphone programming module for 14a control unit

**Technical features:**

Supply	5 Vdc
Frequency	2,4 GHz
Protection degrees	IP 40
Transm. consumption	20 mA
Antenna	integrated
Operating temperature	-20 ÷ +55°C
Weight	12 g

### PRODUCT DESCRIPTION AND FINAL USE

Module dedicated to the technician for wireless programming of control board 14A by smartphone, from firmware 3.0. Use of KUBE PRO is restricted to registration through App and account authorization by Key Automation. Compatible with smartphone Android and Apple equipped with Bluetooth 4.0 LE and APP native for Android 5.0/iOS 9.3.5 or superior with multiin-

gual support.

### Any other use is strictly forbidden!

The manufacturer **Key Automation S.r.l.** Via Meucci 23, 30027 San Donà di Piave (VE) ITALIA Declares that this product was designed and made according to all technical regulations related to this product and in full respect of all range of applications session 2014/53/EU. All radiofrequency tests have been performed

with positive result.

EN 61000-6-2:2017  
EN 61000-6-3:2007 + A1:2011  
EN 301 489-1:2017 V2.2.0  
EN 301 489-17:2017 V3.2.0  
EN 300 328:2016 V2.1.1  
EN 62368-1:2014 + EC:2015 + A11:2017



Nicola Michelin  
(C.E.O.)

*Nicola Michelin*

## INSTRUCTIONS POUR L'INSTALLATEUR

FR

### Module pour la programmation de la centrale 14a avec smartphone

**Caractérist. techniques:**

Alimentation	5 Vdc
Fréquence	2,4 GHz
Degrés de protection	IP 40
Consom. de l'émission	20 mA
Antenne	intégré
Temp. de fonctionnement	-20 ÷ +55°C
Poids	12 g

### DESCRIPTION ET UTILISATION DU PRODUIT

Module dédié à l'installateur pour la programmation wireless de la centrale 14a avec smartphone, avec firmware 3.0. Pour utiliser le KUBE il faut nécessairement s'enregistrer par l'App et obtenir l'habilitation de Key Automation Compatible avec smartphone Android et Apple équipés de Bluetooth 4.0 LE et App native pour Android 5.0/iOS 9.3.5 ou supérieur avec support

multi-langue.

### Toute autre utilisation est strictement interdite!

Le fabricant **Key Automation S.r.l.** Via Meucci 23, 30027 San Dona di Piave (VE) ITALIA Déclare que ce produit est conforme à toutes les réglementations techniques applicables au produit dans le champ d'application de la directive 2014. Ils ont effectué tous les tests de fréquences radioélectriques nécessaires.

EN 61000-6-2:2017  
EN 61000-6-3:2007 + A1:2011  
EN 301 489-1:2017 V2.2.0  
EN 301 489-17:2017 V3.2.0  
EN 300 328:2016 V2.1.1  
EN 62368-1:2014 + EC:2015 + A11:2017



Nicola Michelin  
(C.E.O.)

*Nicola Michelin*

## INSTRUCCIONES PARA EL INSTALADOR

ES

### Modulo para la programación de la central 14a a través smartphone

**Características técnicas:**

Sumin. de energía	5 Vdc
Frecuencia	2,4 GHz
Grados de protección	IP 40
Consumo de la transm.	20 mA
Antena	integrado
Temp. de operación	-20 ÷ +55°C
Peso	12 g

### DESCRIPCIÓN DEL PRODUCTO Y USO FINAL

Módulo dedicado al instalador para la programación wireless a través del smartphone de la central 14A, a partir de la versión firmware 3.0. La utilización del KUBE PRO está vinculada a al registro a través de la App y habilitación de la cuenta de parte de Key Automation. Compatible con smartphone Android e Apple dotados de Bluetooth 4.0 LE y App originales para Android 5.0/iOS 9.3.5 o superior dota-

dos de multi-idioma. ¡Cualquier otro uso está estrictamente prohibido!

El fabricante **Key Automation S.r.l.** Via Meucci, 30027 San Donà di Piave (VE) ITALIA declara que este producto fue diseñado y fabricado de acuerdo con todas las regulaciones técnicas relacionadas para producto y con un completo respeto de todos los rangos de aplicaciones de acuerdo a la sesión 2014/53/EU. Todas las pruebas de radiofrecuencia han sido realizadas con

resultados positivos.

EN 61000-6-2:2017  
EN 61000-6-3:2007 + A1:2011  
EN 301 489-1:2017 V2.2.0  
EN 301 489-17:2017 V3.2.0  
EN 300 328:2016 V2.1.1  
EN 62368-1:2014 + EC:2015 + A11:2017



Nicola Michelin  
(C.E.O.)

*Nicola Michelin*

## INSTALLATIONSANLEITUNGEN

DE

### Modul zur Programmierung der Steuereinheit 14A mit dem Smartphone

**Technische Eigenschaften:**

Speisung	5 Vdc
Frequenz	2,4 GHz
Schutzgrad	IP 40
Sendeverbrauch	20 mA
Antenne	eingebaut
Betriebstemperatur	-20 ÷ +55°C
Gewicht	12 g

### PRODUKTBESCHREIBUNG UND BESTIMMUNGSZWECK

Modul für den Installateur zur drahtlosen Programmierung der Steuereinheit 14A ab Firmware-Version 3.0 mit dem Smartphone. Die Verwendung von KUBE PRO setzt die Anmeldung mittels App und Kontofreigabe durch Key Automation voraus. Verträglich mit Android und Apple Smartphones, die mit Bluetooth 4.0 LE und nativen Apps für Android 5.0/iOS 9.3.5 oder höher mit mehrsprachiger

Unterstützung ausgestattet sind.

### Jeder sonstige Gebrauch gilt als missbräuchlich und ist verboten!

Der Hersteller Key Automation S.r.l., Via Meucci, 30027 San Donà di Piave (VE) ITALIEN, erklärt, dass dieses Produkt allen technischen Produktvorschriften im Rahmen des Anwendungsbereichs der Richtlinie 2014/53/EU entspricht. Alle erforderlichen Funkfrequenzprüfungen wur-

den durchgeführt.

EN 61000-6-2:2017  
EN 61000-6-3:2007 + A1:2011  
EN 301 489-1:2017 V2.2.0  
EN 301 489-17:2017 V3.2.0  
EN 300 328:2016 V2.1.1  
EN 62368-1:2014 + EC:2015 + A11:2017



Nicola Michelin  
(C.E.O.)

*Nicola Michelin*



NOI LY MONTA UNO KEY

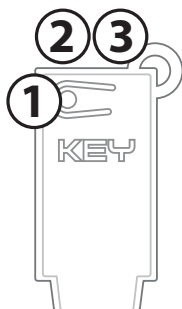

1. RESET
2. RED LED (HW monitoring)
3. BLUE LED (APP monitoring)



**Key Automation S.r.l.**  
Via Meucci 23, 30027 San Donà di Piave VENEZIA - ITALIA  
T. +39 0421.307.456  
F. +39 0421.656.98  
www.keyautomation.it  
info@keyautomation.it

580KUBEPRO REV.02

Fig 1.1 DOWNLOAD KUBE PRO APP AND REGISTER

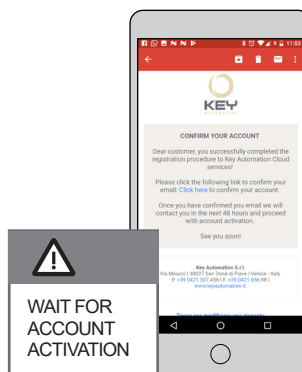
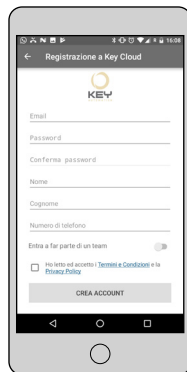
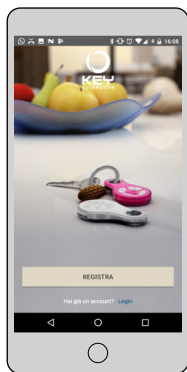
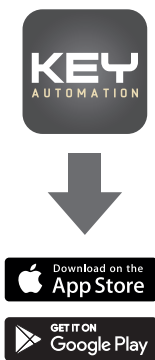

Fig 2.1 CONNECT KUBE

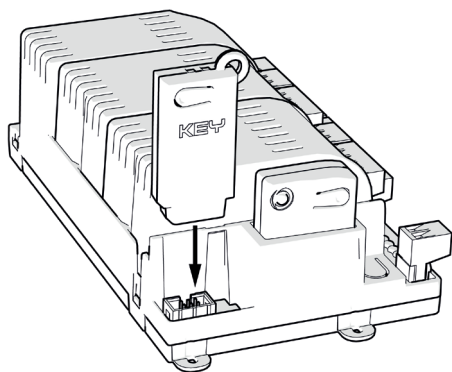

Fig 2.2 WAIT FOR RED AND BLUE LEDS FLASHING

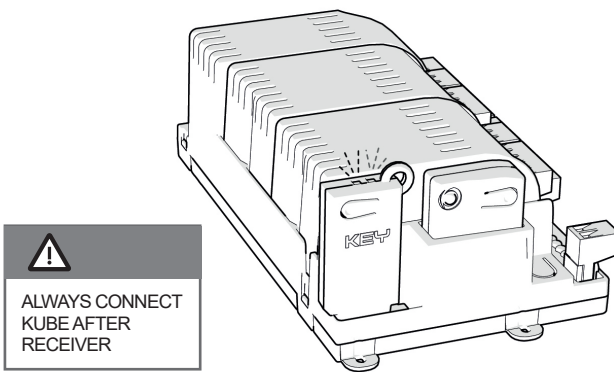

Fig 2.3 ADD NEW KUBE

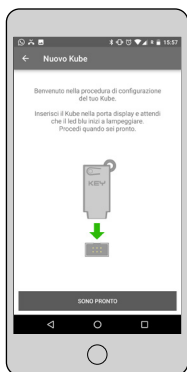

Fig 2.4 ADD NEW CUSTOMER

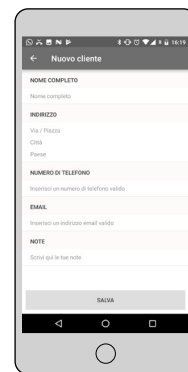

Fig 2.5 ADD NEW INSTALLATION

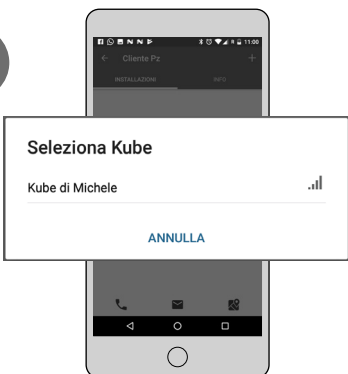

Fig 2.6 DOOR SETTINGS AND CONFIGURATION

